



LuxStudio

Plato Table



Australian made | ISO 14001 Certified | 4-6 week lead time | Tasmanian oak & metal

Plato Table Square Range - 720/900/1050mm Height

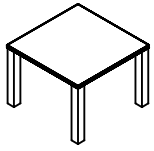

1000mm x 1000mm

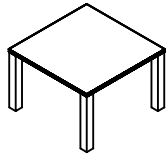

1100mm x 1100mm

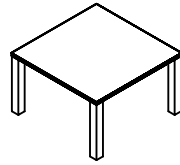

1200mm x 1200mm

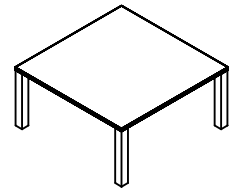

1500mm x 1500mm

Plato Table Rectangle Range

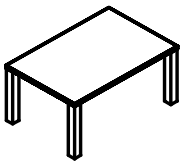

1500mm x 1000mm

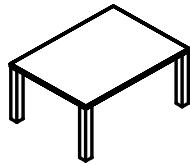

1500mm x 1100mm

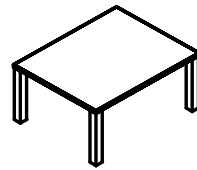

1500mm x 1200mm

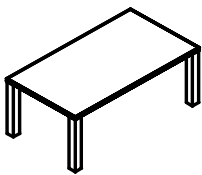

1800mm x 1000mm

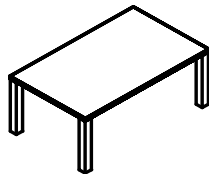

1800mm x 1100mm

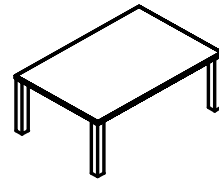

1800mm x 1200mm

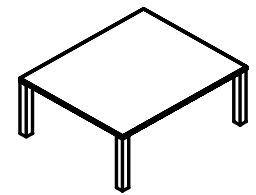

1800mm x 1500mm

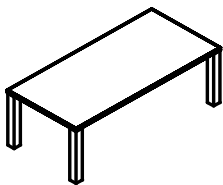

2100mm x 1000mm

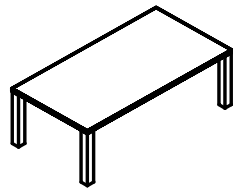

2100mm x 1100mm

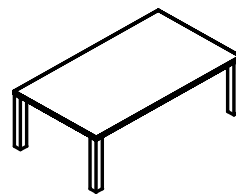

2100mm x 1200mm

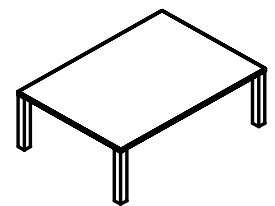

2100mm x 1500mm

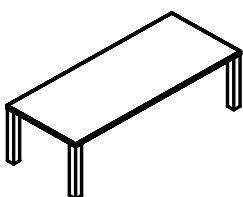

2400mm x 1000mm

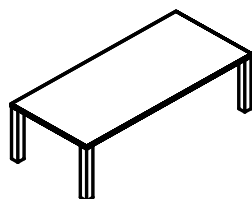

2400mm x 1100mm

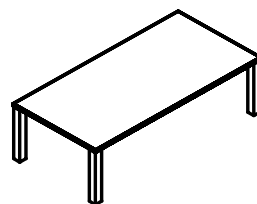

2400mm x 1200mm

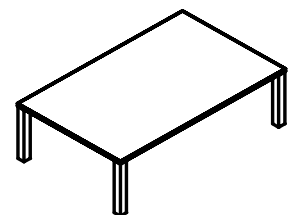

2400mm x 1500mm

Plato Table Segmented Two-Piece Rectangle Range - 720/900/1050mm Height

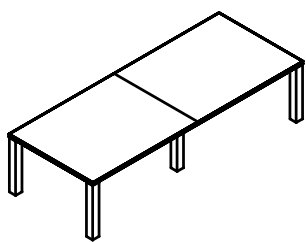

3000mm x 1200mm

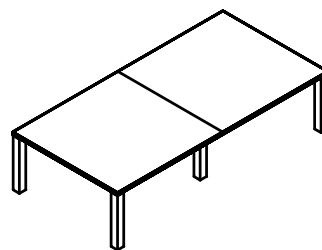

3000mm x 1500mm

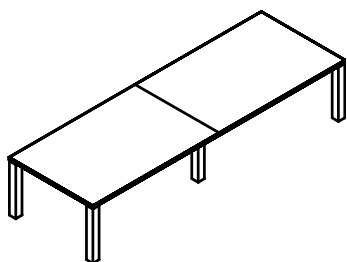

3600mm x 1200mm

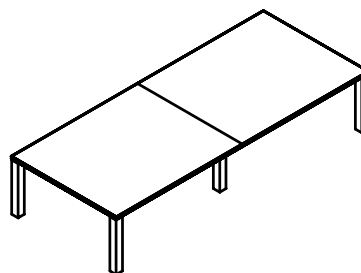

3600mm x 1500mm

Plato Table Segmented Three-Piece Rectangle Range

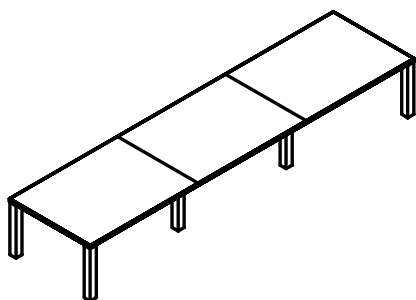

4800mm x 1200mm

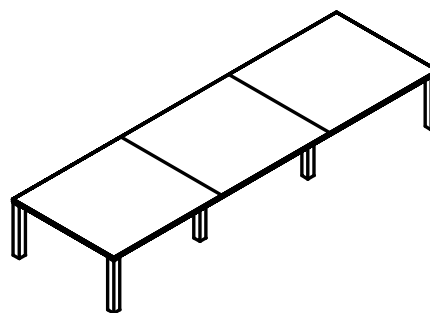

4800mm x 1500mm

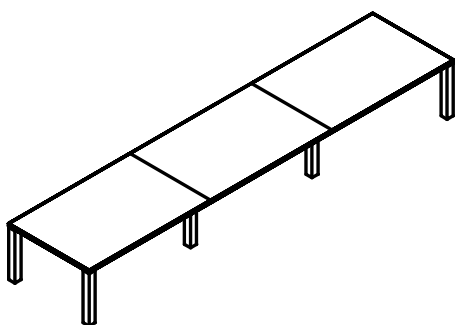

5400mm x 1200mm

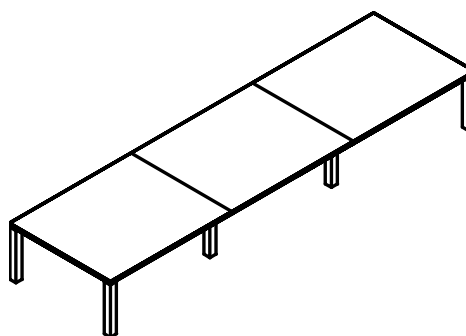

5400mm x 1500mm



Plato Table

The Plato is a simple but strong table range, built to last and complemented with a subtle shadow line where the legs joins the top.

Hidden within in each leg are self-leveling glides to ensure a stable and even surface.

Power and data wire management can be intergrated into each leg as an option.

The Plato table range has a minimum top thickness of 33mm.

All our tables are Australian designed and made.

Material	Tasmanian Oak Metal
Lead time	4-6 weeks
Warranty	5 years
Certified	ISO 14001

